



# GDX Next Entrance Panel Expansion Unit Third-party Access Control

## Quick Start Guide v1.0

Mar 2026

p/n: **EEU** GDX Next Entrance Panel Expansion Unit using Third-party Control

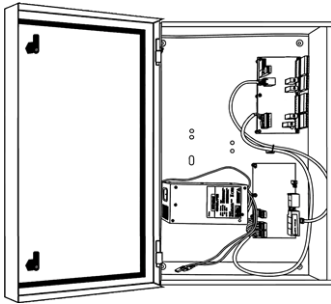

*Technical Documentation*

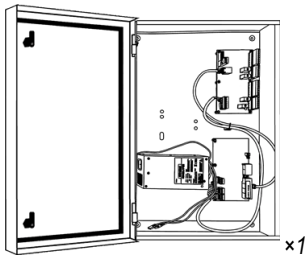

**EEU**



## Health & Safety



**Failure to follow installation instructions may increase the risk of injury or death by electric shock, and may cause damage to hardware.**

### Intended use

This product is designed and manufactured for use in the creation of audio and video communication systems in residential and public buildings.

### Installation and Safe usage

COMELIT-PAC products must be installed to:

- Meet the requirements of the country of installation's National Wiring Regulations (BS7671, IET National Wiring Regulations in the UK) and EN60950-1.
- Be carried out by suitably competent, qualified and experienced personnel.
- Comply with any local fire, health and safety regulations.
- Ensure hardware and controllers (e.g. entrance panels, readers, door controllers, etc.) are earthed.
- Ensure hardware is isolated at the power supply before commencing work on the unit(s).

### Cabling

Control systems' cabling should be installed to reduce interference with other equipment and / or building environment.

- Do not run system cables alongside any heavy load switching cables.
- When you must run close to HV cables cross the cable at right angles every 1–2 m / 3–6 ft.
- To ensure safety, compliance, and ease of maintenance, we strongly recommend that all Extra Low Voltage (ELV) cabling be installed using dedicated sectioned cable trays or protective tubing.

### For new installations

- PAC Secure Data Bus (SDB) requires a minimum of 4-core 0.5mm<sup>2</sup> cable.
- 4-core unshielded (2-wire 0.5mm<sup>2</sup> (gnd) + 2-wire 0.22mm<sup>2</sup>)
- Lock power connections must use 2-core 0.75 mm<sup>2</sup>.

### For retrofit options



**For existing cabling, use cables with a cross-section suited to the current requirements and distances involved for data and lock connections.**

### Maintenance

- Any damaged or faulty products must be reported to COMELIT-PAC Technical Support.
- Any attempt to carry out repairs or modification to the electronic components or the physical product will void the product warranty.
- Do not use alcohol or aggressive products for cleaning purposes.



**If a sealed lead acid battery is installed, make a visual inspection twice a year for signs of damage or overcharging, to prevent possible fire risk.**

### ESD Precautions

The product contains static-sensitive devices and an earth grounding strap should be worn when handling the hardware.

### Equipment Electrical Rating

All electrical equipment should have electrical ratings clearly stated on an identification label and in any documentation provided. Any applicable fuse ratings will also be specified within the documentation.

### WEEE Directive and Product Disposal



At the end of its serviceable life this product should not be treated as household or general waste. It should be handed over to the applicable collection point for the recycling of electrical and electronic equipment or returned to the supplier for disposal.

### Disclaimer

COMELIT-PAC Ltd. does not assume any responsibility for:

- Any purpose other than the intended use.
- Failure to observe the indications and warnings contained in this manual / instruction sheet.



**COMELIT-PAC Ltd. reserves the right to change the information provided in this manual at any time and without prior notice.**

## 1.0 Cable requirements

	Type	Distance
To Entrance Panels	Min. 4-core 0.5mm <sup>2</sup>	100m max
	CAT5e (UTP)	
To CCU	CAT5e (UTP)	
Network connection	CAT5e (UTP)	

## 2.0 Specifications

<b>Enclosure Dimensions</b>	403.5(w) × 606(l) mm	Cover
	399(w) × 598(l) × 96.8(d) mm	Rear
<b>Weight</b>	Approx. 11.5kg	
<b>Operating temperature</b>	−5 °C to +40 °C	
<b>Humidity (RH max)</b>	25% to 75% environmental class A1	

## 3.0 Installation – Enclosure

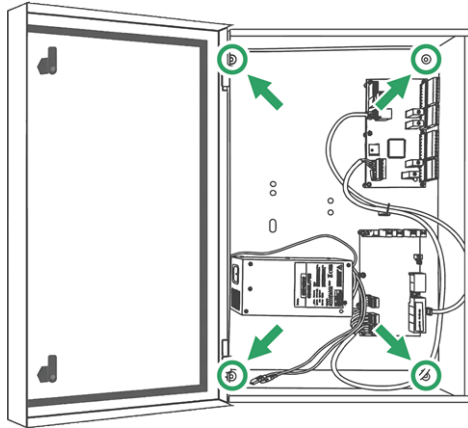

- Use appropriate fixings to secure the enclosure at the indicated positions.

**!** It is the responsibility of the competent and trained individual to observe appropriate precautions when handling, lifting or installing heavy loads that require wall mounting.

**!** Equipment should be installed in a safe location and be accessible for service personnel.

1. We recommend drilling additional cable openings BEFORE fixing to a wall.
2. For any additional holes required for cable entry:
  - i) Unlock the enclosure with the keys provided and remove the door.
  - ii) Remove the equipment mounting plate.
  - iii) Drill required holes and safely remove any remaining metal shards before fitting cable glands.



Use an appropriate cable gland suitable for the location of the enclosure.

3. Site the enclosure in a dry environment and mount vertically on a flat wall.
4. Use appropriate wall fixings to secure the enclosure to the wall.

### Optional Battery Backup

The PSU comes complete with connections for a 7A/h battery including the charging circuit.

## 4.0 3rd-Party Access Control Interface Board layout

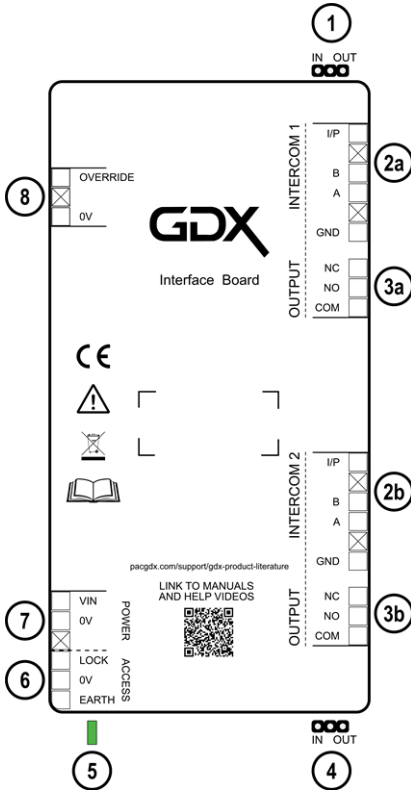

#	Detail
1	RS-485 channel terminators
2a, 2b	Intercom # connections
3a, 3b	Intercom # output
4	PAC Secure Data Bus (SDB) channel terminators
5	System status LED
6	Lock supply output
7	PSU input
8	Override connection

### PAC SDB terminators (#1 & #4)

Check the JUMPER is set to IN.

**IN**

Pins 1 & 2

**OUT**

Pins 2 & 3

## Intercom # connections (#2a & #2b)

Connection	Description
I/P	Input for 3rd-party Access Control Unit (ACU). The input should be <b>closed</b> by the ACU when the door is unlocked.
B	Connections for Entrance Panel PAC SDB channels and 0V
A	
GND	

**! Normally Open dry contact only**

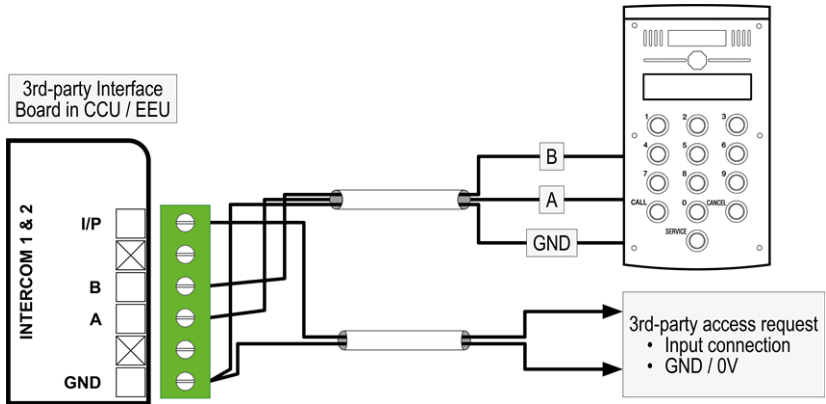

## “Lock Request” wiring (#3a & #3b)

<b>NC</b>	Normally closed
<b>NO</b>	Normally open
<b>COM</b>	Common

Handset “Lock Release” request

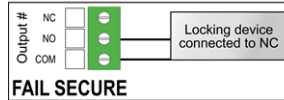
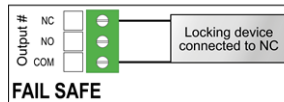

PSU Input available from #11 Access (see layout above)

## Override Terminal (NC)

Override is a Normally Closed circuit.

**Compliance**

Do not discard this product along with other household waste. It must be collected and treated separately.

This page intentionally left blank

This page intentionally left blank

This page intentionally left blank

## 5.0 Troubleshooting

### No power to EEU PCA / 4 Door Controller

- Check voltage from PSU is ~13.8V DC
- Check PSU LED status - refer to manufacturer label
- Verify POWER connections (VIN, 0V, MSTAT) are correctly terminated
- Ensure terminal blocks inserted fully into female terminator on EEU PCA

### Reader Discovery issues

- Typically resolves in under 2 mins.
- Can take up to 5 minutes depending on cable distances and system parameters.
- Max. 100m distance from CCU to Reader.

### Comms issues with Door Readers

- Ensure all connections are correctly terminated on 4 Door Controller
- Verify EEU PCA “CTRL” connection is fully inserted.
- Verify 4 Door Controller “TCPIP” connection is fully inserted.
- Check network connection from CCU to primary Entrance Panel is inserted correctly
- 2× readers on same Door channel, Controller jumper = **OUT**.
- 1× reader on Door channel, Controller jumper = **IN**.



Default position for 4 Door Controller jumper is **OUT**

- Door 1 & 2 jumper located at **#3**.
- Door 3 & 4 jumper located at **#6**.

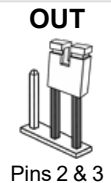
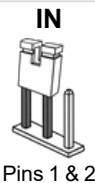

### EEU connection from CCU

- Ensure RJ45 connection is inserted fully

# COMELIT-PAC Ltd.

## South Office

Unit 2b The Quad, Butterfield Business Park,  
Luton, Beds. LU2 8EF

## North Office

Waterside Court, 1 Crewe Rd, Manchester, M23 9BE

T: +44 (0)1707 377203

pacgdxsupport@comelit-pac.co.uk  
pacgdxcustomerservice@comelit-pac.co.uk  
pacgdxsales@comelit-pac.co.uk  
trainingacademy@comelit-pac.co.uk

<https://www.pacgdx.com>